

## DESIGN

Rotisol's most popular line, the GrandFlame combines the beauty of elegant finishes with the highest degree of functionality and cooking quality.

A wide array of spits allow the chef to cook anything that can be roasted: whole or split chickens, lamb, beef roasts and steaks, cuts of pork, porchetta, fish, vegetables, even fruit.

The optional Vertical Spit System with its choice of eight hanging accessories expands the menu possibilities even more and adds additional visual appeal.

## FEATURES

- Energy efficient
- Tempered K-glass doors
- Independent motor for each spit
- Equipped with bottom drip tray with built-in drainage
- Reinforced and anti warping heating element
- Powerful halogen lamps
- Delivered with 8 prongless spits (CUI1375-1400)
- Illuminated sign «Rotisserie» for enamel model only
- Base on casters with brakes









GF1375-8E-LUX

Black porcelain enamel and brass

## TECHNICAL DETAILS

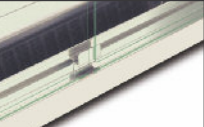
Overview of some of the standard features.

	Reinforced heating elements with stainless steel holders to keep them in place and removable stainless steel panels for easy cleaning.		Emergency stop button type «punch» easily accessible.		Easy and protected access to the compartment of connections and electrical components.
	Switches, in chromed or brass-colored metal		Anti-scald K-glass reduces external thermal radiation (energy saving). Glass overlaps drip pan to keep splatters inside (anti-slip protection).		Removable inside side-panels doubles protection from grease seeping into motors and other sensitive parts

## ACCESSORIES

A variety of accessories are available. See video of available accessories and of vertical spit system online.

<b>CUI1375-1400</b> Anti-cutting prongless V-spit.		<b>BP1375-1400</b> Chicken spit.		<b>BRC1375-1400</b> Rectangular basket spit.	
<b>BS1375-1400</b> Spit for ham / turkey.		<b>BRRO1375-1400</b> Roast-clamp spit.		<b>BA1375-1400</b> Lamb/suckling-pig spit.	
<b>BCR1375-1400</b> Spatchcock chicken basket.		<b>DEC</b> Spit mover.		<b>BPOR1375-1400</b> Porchetta spit.	

**Front view**  
Rotisserie with roof

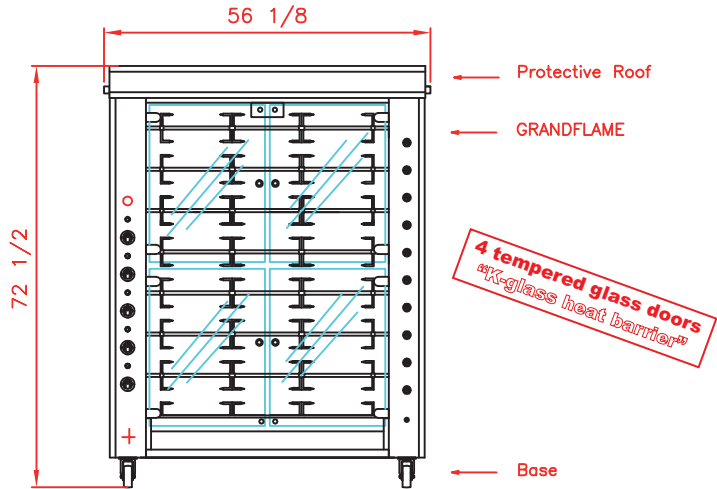

**Top view**  
Rotisserie with roof

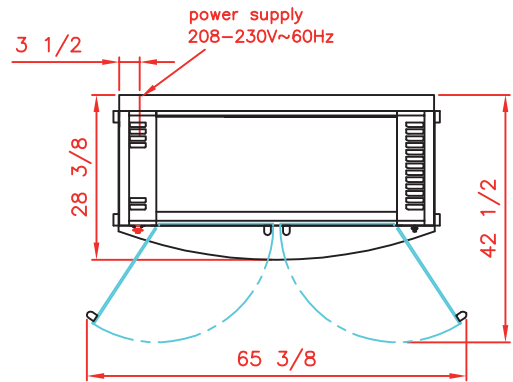

**Side view**  
Rotisserie with roof

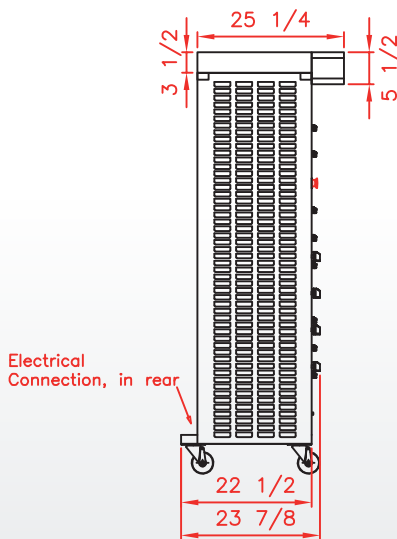

Revised :  
December 2016



GF1375-8E-SSP  
Stainless steel with porcelain enamel

## SPECIFICATIONS

Capacity	40/48 chickens
Power supply	208-230V-60Hz ; 92,5 Amps
Electrical power	33,19 kW
Weight and size (HxDxW)	530 Lbs ; 72 1/2" x 28 3/8" x 56 1/8"
Shipping weight and size	664 Lbs ; 78 3/4" x 30" x 59 1/8"
Warranty	1 year parts and labor

**DISTRIBUTOR / AGENT**

Rotisol France, Inc.  
415 W. Walnut St. Gardena, CA 90248  
[info@rotisolusa.com](mailto:info@rotisolusa.com)  
Ph :310 671 7254  
Fax :310 671 8071