

BBQ

1375-8

DESIGN

Designed to serve your needs in outdoor cooking, big enough to perfectly roast all different sizes of meat. The Super BBQ will be your best ally to bring to weddings, festivals, banquets, picnics... Attractive, easily transportable and easy to clean, the Super BBQ is the equipment that will make the difference...

FEATURES

- Energy efficient
- 2 Tempered K-glass doors
- Heavy duty removable motor
- Drip pan can double as a cutting board
- Rotisol patented burners (engineered and manufactured by Rotisol)
- Easy access for maintenance and high pressure cleaning
- Low maintenance
- All stainless steel and porcelain enamel
- Pilot-thermocouple. Gaz safety valve
- Quick change accessories







1375-8

porcelain enamel and stainless steel finish





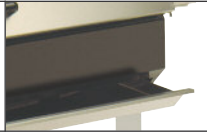
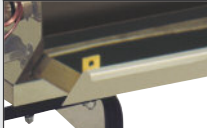

TECHNICAL DETAILS

Overview of some of the standard features.

	Stainless steel burner with removable air filter (Rotisol patent).		2 removable flap-doors with tempered K-glass windows.		Porcelain enamel and stainless steel finish.
	Stainless steel drip pan with drainage valve.		Heavy duty wheels and handle for easy displacement.		Gas safety valve.

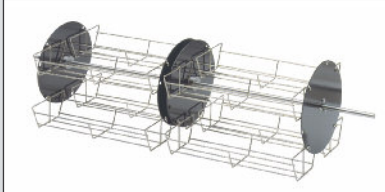
ACCESSORIES

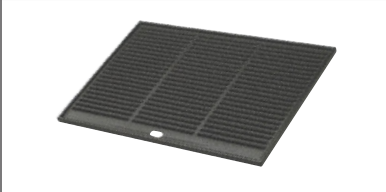
A variety of accessories are available. See video of available accessories and of vertical spit system online.

SB.BAL Revolving basket spit for chicken. Set of 8 baskets.	SB.GP Spit for turkey, pig, ham & sheep.	SB.GRILL 4 cast iron cooking griddles.	BA1675 Lamb/suckling-pig spit.
			

Top view

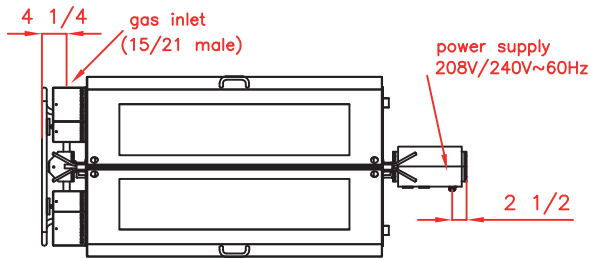

Side view

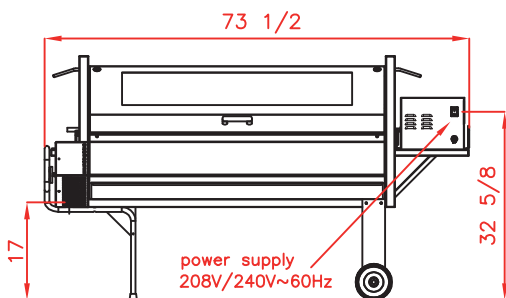

Front view

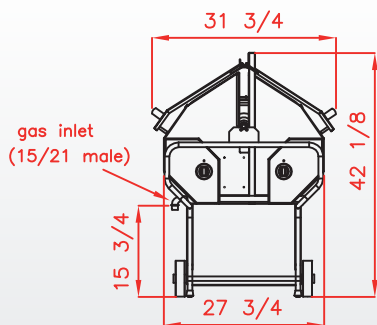

EASY CLEANING
high pressure cleaning
with shielded burners

SPECIFICATIONS

Capacity	24 poultries or 1 lamb
Gas power	112600 BTU/h
Power supply	208-240V-60Hz ; 0,42 Amps
Electrical power	0,1 kW
Weight and size (HxDxW)	342 Lbs ; 42 1/8 x 31 1/4 x 73 1/2
Shipping weight and size	441 Lbs ; 44 1/8 x 35 1/2 x 84 3/4
Warranty	1 year parts and labor



Revised :
February 2019

DISTRIBUTOR / AGENT

Rotisol France, Inc.
415 W. Walnut St. Gardena, CA 90248
info@rotisolusa.com
Ph :310 671 7254
Fax :310 671 8071

