

FauxFlame™ FFS1100-4G

DESIGN

The FAUXFLAME range of rotisseries has been designed with performance, practicality and mobility in mind. Light weight and compact FAUXFLAME is the ideal rotisserie for markets and food trucks and offers rapid production together with excellent cooking quality.

Conscious of the costs involved for our clients, the FAUXFLAME rotisserie has energy-saving infrared burners, patented by Rotisol, that enable the rapid roasting of a variety of products.

FEATURES

- All stainless steel unit
- Front and back visibility and accessibility
- Independent infrared gas burners with interchangeable ceramic bricks
- 4 K-glass doors
- Bottom drip tray with drainage tap
- Interior halogen lighting

BRASILIA

- 27 chickens in 30 minutes
- Reduced gas consumption 9 spits = 41000 (btu/h)
- Compact design with optimized dimensions (shallow depth: 21 1/8)
- Quick return on investment





NEW

FFS1100-4G

All stainless steel

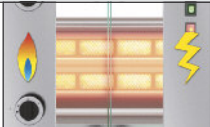

TECHNICAL DETAILS

Overview of some of the standard features.

	<p>Replaceable ceramic bricks for significant financial savings.</p>		<p>Bottom drip tray with drainage tap.</p>		<p>Gas safety ! separation of the gas and electric chambers avoids any risks of explosion.</p>
	<p>Interior halogen lighting.</p>		<p>Anti-scald K-glass reduces external thermal radiation (energy saving). Glass overlaps drip pan to keep splatters inside (anti-slip rotation).</p>		<p>Support bar for support of spit in open position, during the loading and unloading of chickens from the rotisserie.</p>

ACCESSORIES

A variety of accessories are available. See video of available accessories and of vertical spit system online.

<p>BCR---- Spatchcock chicken basket.</p>		<p>DEC Spit mover.</p>		<p>AT Gas lighter.</p>	
-----------------------------------------------	-------------------------------------------------------------------------------------	----------------------------	--------------------------------------------------------------------------------------	----------------------------	---------------------------------------------------------------------------------------

Front view

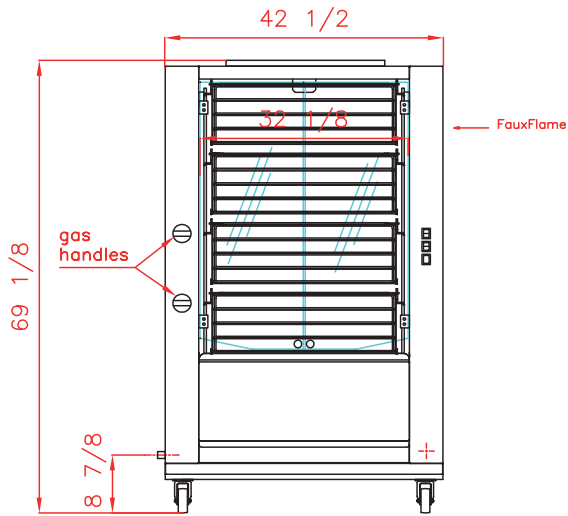

Top view

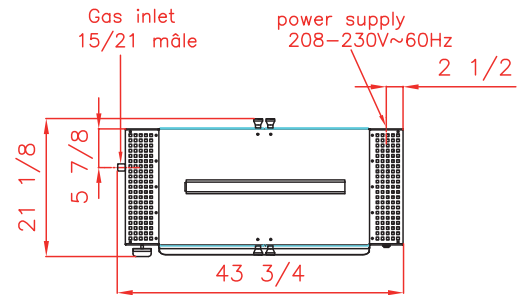

Side view

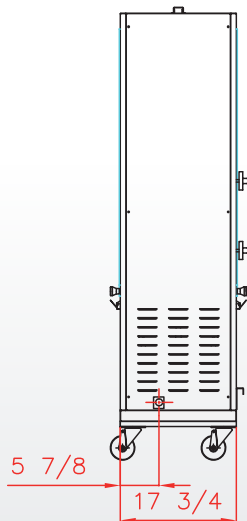

Revised :
September 2018



FFS1100-4G
All stainless steel

SPECIFICATIONS

Capacity	27 chickens
Gas power	41000 BTU/h
Power supply	208-230V-60Hz ; 1,1 Amps
Electrical power	0,23 kW
Weight and size (HxDxW)	364 Lbs ; 69 1/8 x 21 1/8 x 43 3/4
Shipping weight and size	485 Lbs ; 77 1/4 x 30 x 48 1/8
Warranty	1 year parts and labor

DISTRIBUTOR / AGENT

Rotisol France, Inc.
415 W. Walnut St. Gardena, CA 90248
info@rotisolusa.com
Ph: 310 671 7254
Fax: 310 671 8071

