

DESIGN

Rotisol's most popular line, the GrandFlame combines the beauty of elegant finishes with the highest degree of functionality and cooking quality.

A wide array of spits allow the chef to cook anything that can be roasted: whole or split chickens, lamb, beef roasts and steaks, cuts of pork, porchetta, fish, vegetables, even fruit.

The optional Vertical Spit System with its choice of eight hanging accessories expands the menu possibilities even more and adds additional visual appeal.

FEATURES

- Energy efficient
- Tempered K-glass doors
- Independent motor for each spit
- Equipped with bottom drip tray with built-in drainage
- Reinforced and anti warping heating element
- Powerful halogen lamps
- Delivered with 8 prongless spits (CUI975)
- Illuminated sign «Rotisserie» for enamel model only
- Base on casters with brakes

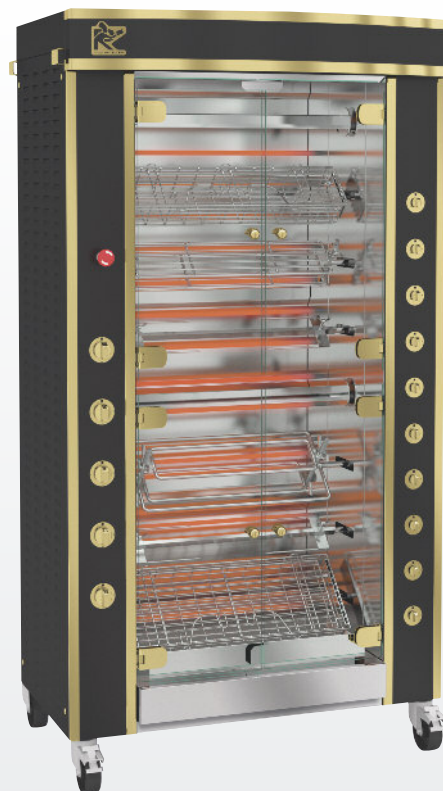







GF975-8E-LUX

Black porcelain enamel and brass

TECHNICAL DETAILS

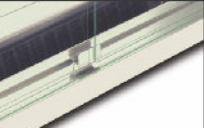
Overview of some of the standard features.

	Reinforced heating elements with stainless steel holders to keep them in place and removable stainless steel panels for easy cleaning.		Emergency stop button type «punch» easily accessible.		Easy and protected access to the compartment of connections and electrical components.
	Switches, in chromed or brass-colored metal		Anti-scald K-glass reduces external thermal radiation (energy saving). Glass overlaps drip pan to keep splatters inside (anti-slip protection).		Removable inside side-panels doubles protection from grease seeping into motors and other sensitive parts

ACCESSORIES

A variety of accessories are available. See video of available accessories and of vertical spit system online.

CUI975 Anti-cutting prongless V-spit.		BP975 Chicken spit.		BRC975 Rectangular basket spit.	
BS975 Spit for ham / turkey.		BRRO975 Roast-clamp spit.		BA975 Lamb/suckling-pig spit.	
BCR975 Spatchcock chicken basket.		DEC Spit mover.		BPOR975 Porchetta spit.	

Front view
Rotisserie with roof

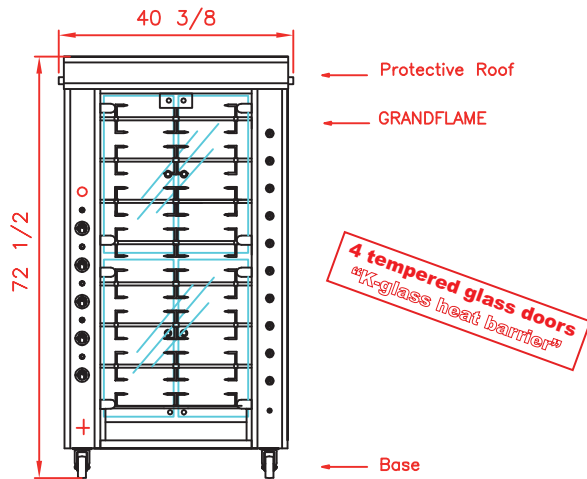

Top view
Rotisserie with roof

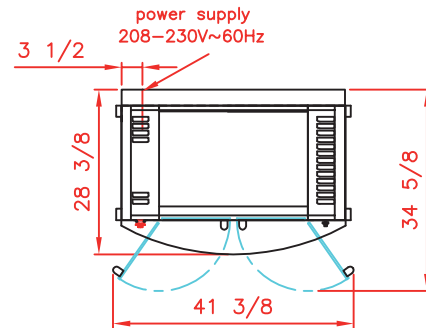

Side view
Rotisserie with roof

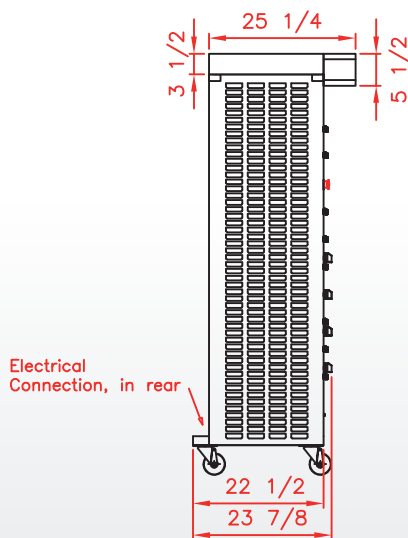

Revised :
December 2016



GF975-8E-SSP
Stainless steel with porcelain enamel

SPECIFICATIONS

Capacity	16/24 poultries
Power supply	208-230V-60Hz ; 61 Amps
Electrical power	21,49 kW
Weight and size (HxDxW)	350 Lbs ; $72 \frac{1}{2}$ x $28 \frac{3}{8}$ x $40 \frac{3}{8}$
Shipping weight and size	484 Lbs ; $78 \frac{3}{4}$ x 30 x $42 \frac{1}{8}$
Warranty	1 year parts and labor

DISTRIBUTOR / AGENT

Rotisol France, Inc.
415 W. Walnut St. Gardena, CA 90248
info@rotisolusa.com
Ph :310 671 7254
Fax :310 671 8071